



CDAS/OFAS Large Flow Clean Dry and Oil-Free Air Systems For General Industrial Manufacturing



ENGINEERING YOUR SUCCESS.

Clean, Dry and Oil-Free Compressed Air

For general industrial manufacturing, the uses of compressed air differ greatly, and therefore so does the purity (quality) of compressed air required.

ISO 8573-1 is the international standard for compressed air purity (quality). It provides an easy to use classification method that allows a manufacturing facility to specify the compressed air purity (quality) they require.

Unfortunately, the ISO 8573-1 standard does not provide any guidance as to which air purity classifications are recommended for a particular industry or application.

To assist in the selection of a suitable compressed air purity classification, Parker have produced a number of industry specific documents which provide a recommended air purity (quality) for specific industries and applications, plus suitable compressed air treatment technologies to meet or exceed those air purity recommendations.

Compressed Air Purity Recommendations by Industry Sector

	General Manufacturing (Including Automotive)	Electronics Manufacturing and Semiconductor Production	Food and Beverage Manufacturing	Pharmaceutical Manufacturing	Oil and Gas
Typical Applications	General Industrial Compressed Air (Internal Piping System)	CDA (Clean Dry Air) Semiconductor	Food and Beverage Grade Air Direct Contact Applications (Control over Microbial Growth)	Pharmaceutical Grade Air Direct Contact Applications (Control over Microbial Growth)	General Air (Safe Areas)
	General Industrial Compressed Air (External Piping System)	Instrument Air	Food and Beverage Grade Air In-direct Contact Applications (Control over Microbial Growth)	Pharmaceutical Grade Air In-direct Contact Applications (Control over Microbial Growth)	General Air (Zoned Areas)
	General Industrial 'Technically' Oil-Free Compressed Air	General Air	General Air Non-Contact Applications	General Air Non-Contact Applications	Instrument Air (Safe Areas)

Recommended Minimum Air Quality Classifications

General Industrial Manufacturing (Including Automotive)			Recommended Parker Compressed Air Treatment Products	
Application	Recommended ISO 8573-1:2010 Purity (Quality) Classifications	Pressure Dewpoint (PDP) Band	Clean Dry Air System	Oil-Free Air System
General Industrial Compressed Air (External Piping System)	ISO 8573-1:2010 Class 2:2:2 ISO 8573-1:2010 Class 2:1:2 ISO 8573-1:2010 Class 2:3:2	-69°C to -40°C -80°C to -70°C -39°C to -20°C	CDAS HL 100 - 170 CDAS LE 100 - 170	-
General Industrial 'Technically' Oil-Free Compressed Air	ISO 8573-1:2010 Class 2:2:1 ISO 8573-1:2010 Class 2:1:1	-69°C to -40°C -80°C to -70°C	-	OFAS HL 100 - 170 OFAS LE 100 - 170
Spray Painting	ISO 8573-1:2010 Class 2:2:1	-69°C to -40°C	-	OFAS HL 100 - 170 OFAS LE 100 - 170
Respiratory Protection	EN 12021	≤ -40°C PDP	For Breathable Quality Compressed Air (Industrial Use) to EN 12021 use Parker BAS / BAM / BSP Product Ranges	

CDAS/OFAS

Clean Dry and Oil-Free Air Systems

At the heart of any compressed air treatment solution is the dryer, its purpose, to remove water vapour, stop condensation, corrosion and in the case of adsorption dryers, inhibit the growth of microorganisms.

Heatless adsorption dryers (also known as PSA dryers) are the simplest type of adsorption dryer available and have long been the dryer of choice for many industries and applications. They are simple, reliable and cost effective and for small to medium flow systems, often the only viable technology available. Additionally, modular heatless dryers provide even more reliable, smaller, more compact and lightweight dryers, which can be installed in both the compressor room or at the point of use.

CDAS/OFAS systems provide clean, oil-free and dry compressed air in accordance with all editions of ISO8573-1, the international standard for compressed air quality. They are energy efficient and use a modular construction making them less than half the size of conventional dryers.

CDAS HL
Clean Dry Air System



OFAS HL
Oil-Free Air System



OIL-X Pre and Post Filtration
Included in all
CDAS HL and OFAS HL Packages



Features and Benefits

No Heat Required

- As the name suggests, heatless dryers do not use any heat during the regeneration process and do not require a cool down phase.
- Using heat requires insulation to keep the heat in the adsorption bed during regeneration and a cooling phase to remove the heat before adsorption begins again.
- A hot desiccant bed reduces adsorption capacity and can affect the outlet dewpoint on changeover (a problem with ambient air cooled blower dryers, unless costly cool down air is used).
- Heated dryers are typically more complicated than a heatless equivalent.

Clean, Dry Regeneration Air

- Utilising, clean dry 'purge air' for regeneration protects the adsorption bed from ambient contamination and prevents the introduction of these contaminants downstream (unlike regeneration methods using untreated ambient air).

Robust and Reliable

- Simple regeneration means fewer components and increased reliability.

Modular Aluminium Construction

- Modular aluminium construction means a smaller, more compact and lightweight dryer compared to conventional steel dryers.
- 100% standby at a fraction of the cost of twin tower designs.
- 10 year guarantee on pressure envelope
- Corrosion resistance due to anodising and dry powder epoxy coating.
- Consistent outlet dewpoint performance thanks to snowstorm filling of adsorbent desiccant material.

Approvals to International Standards

- PED/CE, UL/FCC, AS1210/RCM and MOM.

Field Upgradable

- To low energy vacuum assisted option (LE).

Parker CDAS Clean Dry Air Systems consist of 4 stages of purification treating 7 contaminants* found in a compressed air system.

1

OIL-X General Purpose Coalescing Filter

REDUCES:

Particulate down to 1 micron, water and oil aerosols down to 0.5 mg/m³.

2

OIL-X High Efficiency Coalescing Filter

REDUCES:

Particulate down to 0.01 micron, water and oil aerosols down to 0.01 mg/m³.

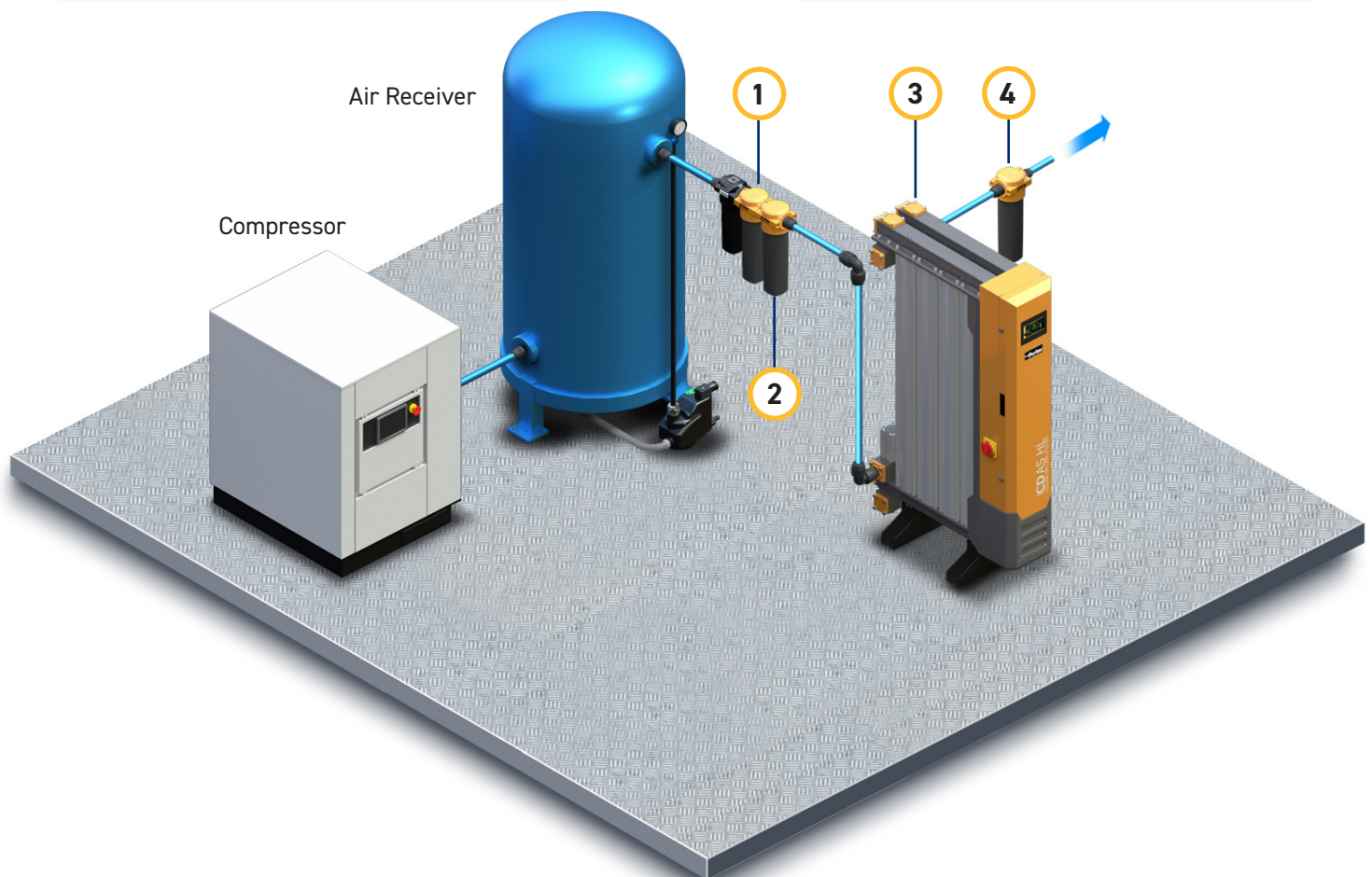

3

Adsorption Dryer

REDUCES:

Water Vapour - PDP \leq -40°C

4

OIL-X General Purpose Dry Particulate Filter

REDUCES:

Particulate down to 1 micron.

*Important Note

Should there be liquid water or liquid oil present at the inlet of the CDAS treatment system, an additional OIL-X Grade WS liquid separator can be installed, increasing the number of contaminants treated from 7 to 9.

Parker OFAS Oil-Free Air Systems consist of 5 stages of purification treating 8 contaminants* found in a compressed air system.

1

OIL-X General Purpose Coalescing Filter

REDUCES:

Particulate down to 1 micron, water and oil aerosols down to 0.5 mg/m³.

2

OIL-X High Efficiency Coalescing Filter

REDUCES:

Particulate down to 0.01 micron, water and oil aerosols down to 0.01 mg/m³.

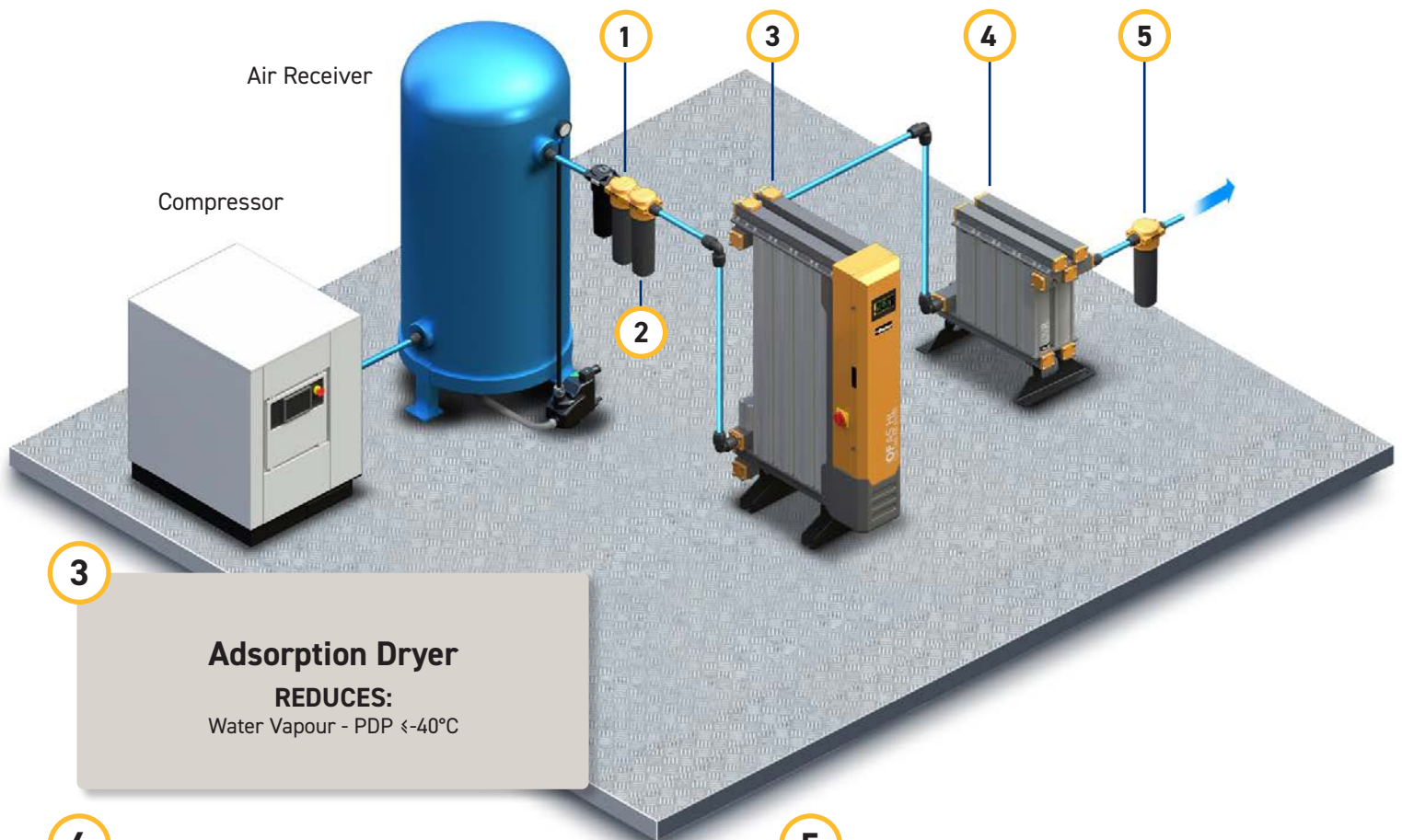

3

Adsorption Dryer

REDUCES:

Water Vapour - PDP \leq -40°C

4

OIL-X OVR Activated Carbon Filter

REDUCES:

Oil vapours down to \leq 0.003 mg/m³

5

OIL-X General Purpose Dry Particulate Filter

REDUCES:

Particulate down to 1 micron.

*Important Note

Should there be liquid water or liquid oil present at the inlet of the OFAS treatment system, an additional OIL-X Grade WS liquid separator can be installed, increasing the number of contaminants treated from 8 to 10.

Advanced Controller

Advanced compressed air treatment systems demand advanced control systems.

Ensuring that compressed air is always within specification and maintenance regimes are adhered to requires an advanced control system. One that not only controls the function of the treatment system but also constantly monitors and advises the dryer status to plant personnel and/or service providers.

The CDAS/OFAS Advanced controller offers multiple connection methods and modern IIoT communication protocols, with the option of custom protocols and cloud connectivity via additional gateways.

The electronic controller includes a multi voltage, multi frequency power supply feeding a PLC controller, housed in an IP44 rated enclosure. A 7" colour touchscreen display is included to show the dryer status and allow full control of the dryer.



Controller Connectivity

Dryer Range / Connectivity	WebsERVER via Ethernet RJ45	Modbus TCP/IP via Ethernet RJ45	Modbus RTU via 2 wire RS485	Dewpoint Hygrometer with 4-20 mA Dewpoint Retransmission	Fault Alarm Relay
CDAS HL 100-170 OFAS HL 100-170	•	•	•	•	•
CDAS LE 100-170 OFAS LE 100-170	•	•	•	•	•

Examples of the CDAS/OFAS Advanced Controller's Touchscreen Displays

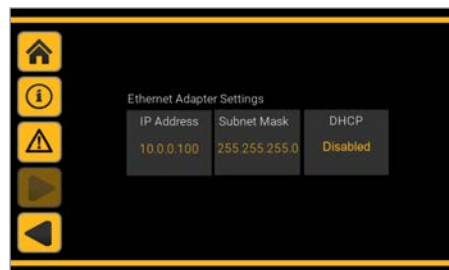

Network Configuration Settings (Ethernet)

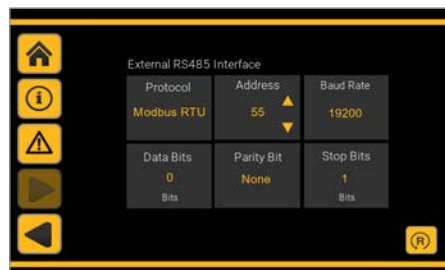

Network Configuration Settings (RS485)

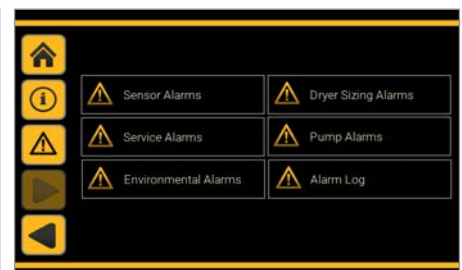

Available Alarm Displays

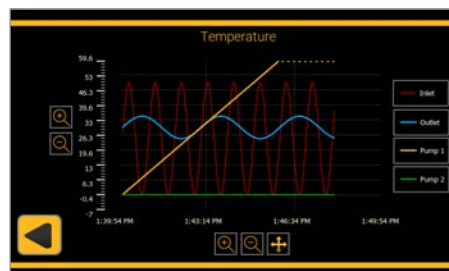

Operational Temperature Trends

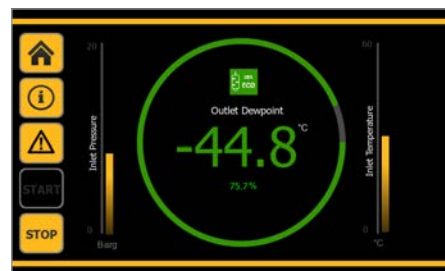

Dewpoint Display

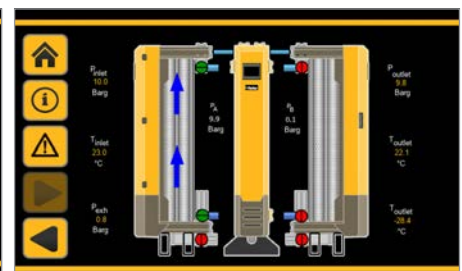

Dryer Operation Status

Energy Saving as Standard

CDAS/OFAS compressed air treatment systems include two energy management systems as standard, DDS-EST and Purge Economy.

Dewpoint Dependent Switching: Energy Saving Technology (DDS-EST)

The energy required to regenerate the off-line desiccant bed of an absorption dryer is constant, and based upon the assumption that the dryer is operating at full capacity and the desiccant bed requiring regeneration has been fully saturated.

In reality, a dryer is rarely operating at full capacity all of the time, for example during shift work and periods of low demand.

Daily and seasonal fluctuations in ambient temperature and humidity also change the moisture loading placed upon the dryer.

Under such conditions, at the point in the drying cycle where the air flow is switched from one drying chamber to the other, there is the potential for drying capacity to remain in the desiccant material about to undergo regeneration.

As the energy used to regenerate this partially saturated bed is based upon the assumption that the bed is fully saturated, more energy (purge air) is consumed than is actually necessary.

Proportional Energy Usage

Parker's Dewpoint Dependent Switching - Energy Saving Technology ensures the energy consumed by the dryer is directly proportional to the amount present and not the dryer's maximum rated capacity.

This example highlights the percentage energy savings available with the DDS-EST in operation.

Example based upon dryer sized for minimum system pressure: 6.5 bar g, maximum inlet temperature: 35°C, 100% dryer flow rate. Average pressure: 7.5 bar g, average temperature: 30°C, average flow: 50% - 100%. Duration of operation: 8736 hours.

% Flow	% Energy Saving					
	35°C	30°C	25°C	20°C	15°C	10°C
100	14%	35%	52%	65%	74%	81%
90	23%	42%	57%	68%	77%	83%
80	31%	48%	62%	72%	79%	85%
70	40%	55%	66%	75%	82%	87%
60	49%	61%	71%	79%	85%	89%
50	57%	68%	76%	82%	87%	91%

DDS-EST not only provides energy savings, it provides environmental savings too!

This example highlights the potential energy savings (in kW) and environmental savings (in kg/CO₂) over a 12 month period of operation.

Example based upon CDAS HL 130. Minimum system pressure: 6.5 bar g, maximum inlet temperature: 35°C, 100% dryer flow rate. Average pressure: 7.5 bar g, average temperature: 30°C, average flow: 50% - 100%. Duration of operation: 8736 hours.

Air Demand %	Energy Saving %	Energy Saving P/A kW	Environmental Saving P/A Kg / CO ₂
100	35	69,236	37,388
90	42	83,084	44,865
80	48	94,953	51,274
70	55	108,800	58,752
60	61	120,669	65,161
50	68	134,516	72,639

Purge Economy: Energy Saving Technology

As standard, CDAS/OFAS compressed air treatment systems are supplied with not one, but two energy saving technologies. Purge Economy compliments the DDS-EST system and allows for additional energy savings to be made when the compressor is offload, for example during evenings and weekends.



CDAS/OFAS LE - Low Energy Vacuum Assisted Heatless Dryers

The purge air requirement for the heatless vacuum assisted dryer is reduced from around 20% to 3% of the dryer's literature reference conditions.

Energy reductions from reducing the purge air offsets the energy required to operate the vacuum pump, and provides significant energy savings overall.

CDAS/OFAS LE heatless vacuum assisted dryers operate almost identically to a standard heatless dryer, however their design includes two additional components, a vacuum valve and a vacuum pump.

Features and Benefits

It's a Heatless Dryer!

- All of the aforementioned benefits a heatless modular aluminium dryer.
- Uses clean, dry, purge air for desiccant regeneration.
- No heat used for regeneration.
- No cooling phase required.
- No thermal protection devices or protective insulation required.

Less Purge Air Required for Regeneration

- Lower air usage, compared to equivalent heatless and heated purge air dryers.
- Up to 17% more compressed air delivered to the application, compared to a standard heatless equivalent.

Energy Savings

- On average 63% lower energy consumption, compared to a standard heatless equivalent.

Heatless Fallback Mode

- Should a problem arise with the vacuum pump, unlike more complicated dryer technologies, CDAS/OFAS LE dryers can be immediately set up in fully heatless mode to ensure a continuous supply of dry air is always available.

Can use existing centralised vacuum system

- If a centralised vacuum system is already available on-site, CDAS/OFAS LE vacuum assisted heatless dryers can be connected to the system, reducing capital costs even further.



OIL-X Pre and Post Filtration
Included in all
CDAS LE and OFAS LE Packages



Multi-Banking

CDAS/OFAS compressed air treatment systems provide greater flexibility with multi-banking.

Unlike traditional twin tower dryer designs, all CDAS/OFAS 100-170 models can be multi-banked to provide extra compressed air drying capacity.

Should demand increase in the future, there is no need to replace the dryer with a larger unit, additional capacity can be covered by simply adding extra dryer modules (banks).



3 x OFAS LE
Multi-bank
Configuration

Flexibility

Multi-banking allows individual dryer banks to be easily isolated for routine service work, whilst maintaining your clean, dry air supply.

Ease of Installation

Unlike traditional twin tower designs, modular dryers will fit through a standard doorway, eliminating the need for special access or facility structural dismantling during installation.

100% Standby

Compared to traditional twin tower designs, 100% standby is available at a fraction of the cost as only one extra dryer bank is required.

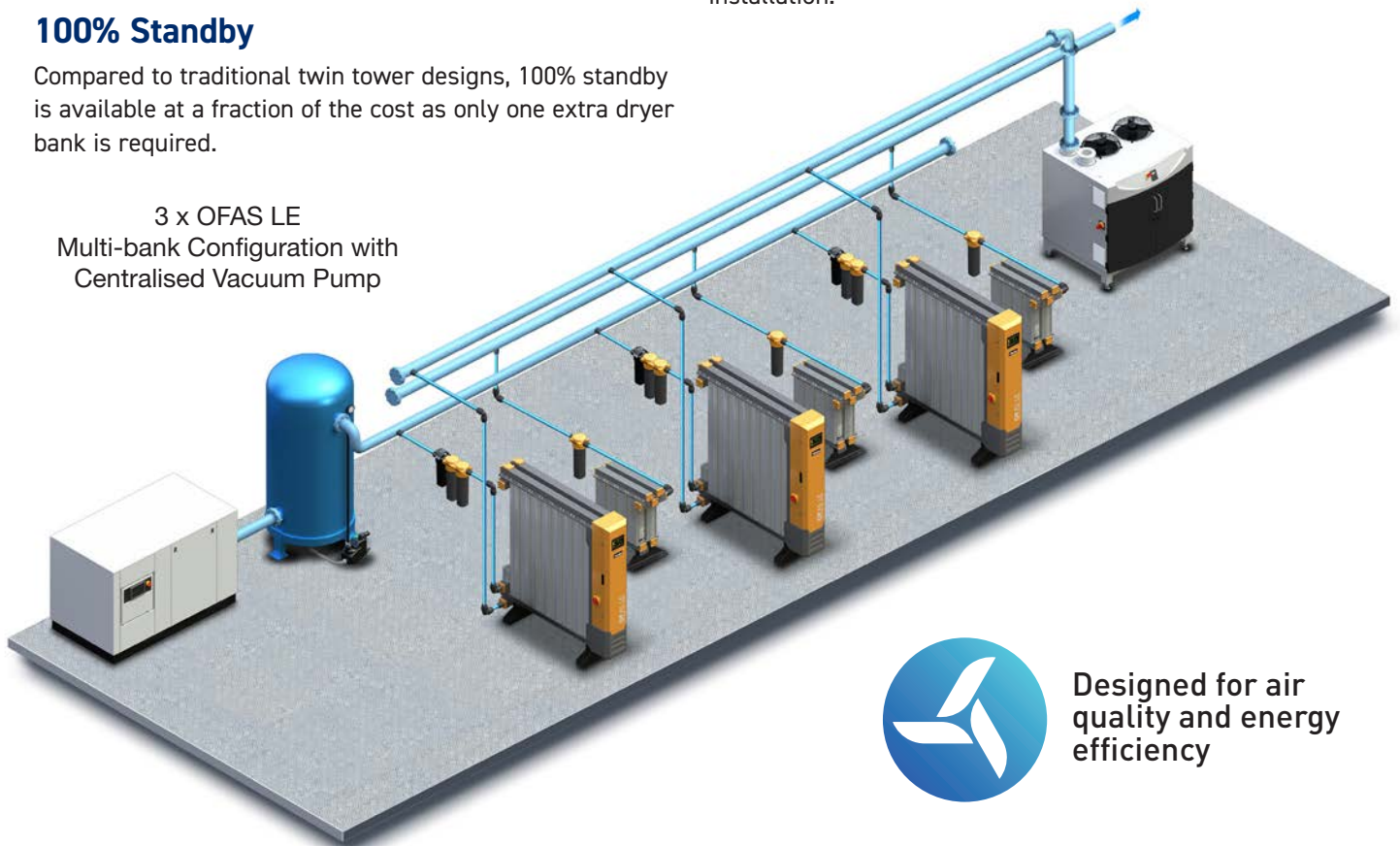

3 x OFAS LE
Multi-bank Configuration with
Centralised Vacuum Pump



Designed for air quality and energy efficiency

Dryer Performance - CDAS HL 100-170

Dryer Models	Dewpoint (Standard)		ISO 8573-1:2010 Classification (Standard)	Dewpoint (Option 1)		ISO 8573-1:2010 Classification (Option 1)	Dewpoint (Option 2)		ISO 8573-1:2010 Classification (Option 2)
	°C	°F		°C	°F		°C	°F	
CDAS HL 100 - CDAS HL 170	-40	-40	Class 2:2:2	-70	-100	Class 2:1:2	-20	-4	Class 2:3:2

ISO 8573-1 Classifications when used with Parker OIL-X pre/post filtration

Technical Data

Dryer Models	Minimum Operating Pressure		Maximum Operating Pressure		Minimum Operating Temperature		Maximum Operating Temperature		Maximum Ambient Temperature		Electrical Supply (Standard)	Electrical Supply (Optional)	Thread Type	Noise Level dB(A)
	bar g	psi g	bar g	psi g	°C	°F	°C	°F	°C	°F				
CDAS HL 100 - CDAS HL 170	5	73	13	190	5	41	50	122	55	131	100-240V (+/-10%) 1ph 50/60Hz	-	BSPP	<75

Flow Rates

Model	Pipe Size	Inlet Flow Rate			
		L/s	m ³ /min	m ³ /hr	cfm
CDAS HL 100	2"	113	6.81	408	240
CDAS HL 110	2"	170	10.22	612	360
CDAS HL 120	2½"	213	12.75	765	450
CDAS HL 130	2½"	283	17	1020	600
CDAS HL 140	2½"	354	21	1275	750
CDAS HL 150	2½"	425	26	1530	900
CDAS HL 160	3"	496	30	1785	1050
CDAS HL 170	3"	567	34	2040	1200
2 x CDAS HL 140	2½"	708	43	2550	1500
2 x CDAS HL 150	2½"	850	51	3060	1800
2 x CDAS HL 160	3"	992	60	3570	2100
2 x CDAS HL 170	3"	1133	68	4080	2400
3 x CDAS HL 150	2½"	1275	77	4590	2700
3 x CDAS HL 160	3"	1488	89	5355	3150
3 x CDAS HL 170	3"	1700	102	6120	3600

Stated flows are for operation at 7 bar (g) (102 psi g) with reference to 20°C, 1 bar (a), 0% relative water vapour pressure. For flows at other pressures, apply the correction factors shown below.

For correct operation, compressed air dryers must be sized for the maximum (summer) inlet temperature, maximum (summer) ambient temperature, minimum inlet pressure, required outlet dewpoint and maximum flow rate of the installation.

CFMIT - Correction Factor Maximum Inlet Temperature

Maximum Inlet Temperature	°C	25	30	35	40	45	50
	°F	77	86	95	104	113	122
Correction Factor		1.00	1.00	1.00	1.04	1.14	1.37

To select a dryer, first calculate the Minimum Drying Capacity (MDC) using the formula below then select a dryer from the flow rate table above with a flow rate equal to or above the MDC.

CFMAT - Correction Factor Maximum Ambient Temperature

Maximum Ambient Temperature	°C	25	30	35	40	45	50
	°F	77	86	95	104	113	122
Correction Factor		1.00	1.00	1.00	1.00	1.00	1.00

Minimum Drying Capacity (MDC) =

Max System Flow x CFMIT x CFMAT x CFMIP x CFOD

CFMIP - Correction Factor Minimum Inlet Pressure

Minimum Inlet Pressure	bar g	4	5	6	7	8	9	10	11	12	13
	psi g	58	73	87	100	116	131	145	160	174	189
Correction Factor		1.60	1.33	1.14	1.00	0.89	0.80	0.73	0.67	0.62	0.57

CFOD - Correction Factor Outlet Dewpoint

Outlet Dewpoint	°C	-20	-40	-70
	°F	-4	-40	-100
Correction Factor		0.91	1.00	1.43

Controller Main Functions

Dryer Models	Controller Function							
	Touchscreen + PLC Controller	Inlet Pressure, Temp. & Outlet Dewpoint Monitoring	DDS Energy Saving Technology	Filter and Dryer Service Indicators	Web Interface via RJ45 Ethernet	I/IOT Connectivity	4-20mA Outputs	Fault Alarm Relay
CDAS HL 100 - CDAS HL 170	•	•	•	•	•	•	•	•

Items Included/Required/Optional to Create CDAS HL Package

Product	Required - To be ordered separately	Included	Optional
OIL-X Grade WS (Installation dependent)	-	-	•
OIL-X Grade AO General Purpose Coalescing Filter	-	•	-
OIL-X Grade AA High Efficiency Coalescing Filter	-	•	-
CDAS Adsorption Dryer	-	•	-
OVR Oil Vapour Reduction Filter	-	-	-
OIL-X Grade AO General Purpose Dry Particulate Filter	-	•	-
HLVAP Vacuum Pump(s) (Includes vacuum valve, 3m vacuum hose and fittings)	-	-	-
Inlet / Outlet Piping (Parker Transair aluminium piping recommended)	•	-	-

Included Filtration

Model	Filter Connections BSPP	Dryer Inlet		Dryer Outlet		
		General Purpose Pre-filter	High Efficiency Filter	Oil Vapour Reduction Filter	General Purpose Dry Particulate Filter	High Efficiency Dry Particulate Filter
CDAS HL 100	2"	AOPX040HGFX	AAPX040HGFX	-	AOPX040HGMX	-
CDAS HL 110	2"	AOPX040HGFX	AAPX040HGFX	-	AOPX040HGMX	-
CDAS HL 120	2½"	AOPX045IGFX	AAPX045IGFX	-	AOPX045IGMX	-
CDAS HL 130	2½"	AOPX045IGFX	AAPX045IGFX	-	AOPX045IGMX	-
CDAS HL 140	2½"	AOPX050IGFX	AAPX050IGFX	-	AOPX050IGMX	-
CDAS HL 150	2½"	AOPX050IGFX	AAPX050IGFX	-	AOPX050IGMX	-
CDAS HL 160	3"	AOPX055JGFX	AAPX055JGFX	-	AOPX055JGMX	-
CDAS HL 170	3"	AOPX055JGFX	AAPX055JGFX	-	AOPX055JGMX	-

Filtration Performance

Filter	General Purpose Pre-filter	High Efficiency Filter	Oil Vapour Reduction Filter	General Purpose Dry Particulate Filter	High Efficiency Dry Particulate Filter
Filtration Grade	Grade AO	Grade AA	-	Grade AO	-
Filtration Type	Coalescing	Coalescing	-	Dry Particulate	-
Particle Reduction (inc. water and oil aerosols)	Down to 1 micron	Down to 0.01 micron	-	Down to 1 micron	-
Maximum Remaining Oil Aerosol Content at 21°C	≤0.5 mg/m ³ (≤0.5 ppm(w))	≤0.01 mg/m ³ (≤0.01 ppm(w))	-	N/A	-
Maximum Remaining Oil Vapour Content at System Temperature	N/A	N/A	-	N/A	-
Filtration Efficiency	99.925%	99.9999%	-	99.925%	-

Required in addition to above - To be ordered separately

	CDAS HL 100 - CDAS HL 170
OIL-X Grade WS (Optional - installation dependent)	•
Inlet / Outlet Piping (Parker Transair aluminium piping recommended)	•

Dryer Performance - CDAS LE 100-170

Dryer Models	Dewpoint (Standard)		ISO 8573-1:2010 Classification (Standard)	Dewpoint (Option 1)		ISO 8573-1:2010 Classification (Option 1)	Dewpoint (Option 2)		ISO 8573-1:2010 Classification (Option 2)
	°C	°F		°C	°F		°C	°F	
CDAS LE 100 - CDAS LE 170	-40	-40	Class 2:2:2	-70	-100	Class 2:1:2	-20	-4	Class 2:3:2

ISO 8573-1 Classifications when used with Parker OIL-X pre/post filtration

Technical Data

Dryer Models	Minimum Operating Pressure		Maximum Operating Pressure		Minimum Operating Temperature		Maximum Operating Temperature		Maximum Ambient Temperature		Electrical Supply (Standard)	Electrical Supply (Optional)	Thread Type	Noise Level dB(A)
	bar g	psi g	bar g	psi g	°C	°F	°C	°F	°C	°F				
CDAS LE 100 - CDAS LE 170	5	73	13	190	5	41	50	122	55	131	400V +/-10% 3PH 50Hz	460V +/-10% 3PH 60Hz	BSPP	<75

Flow Rates

Model	Pipe Size	Inlet Flow Rate			
		L/s	m³/min	m³/hr	cfm
CDAS LE 100	2"	113	6.81	408	240
CDAS LE 110	2"	170	10.22	612	360
CDAS LE 120	2½"	213	12.75	765	450
CDAS LE 130	2½"	283	17	1020	600
CDAS LE 140	2½"	354	21	1275	750
CDAS LE 150	2½"	425	26	1530	900
CDAS LE 160	3"	496	30	1785	1050
CDAS LE 170	3"	567	34	2040	1200
2 x CDAS LE 140	2½"	708	43	2550	1500
2 x CDAS LE 150	2½"	850	51	3060	1800
2 x CDAS LE 160	3"	992	60	3570	2100
2 x CDAS LE 170	3"	1133	68	4080	2400
3 x CDAS LE 150	2½"	1275	77	4590	2700
3 x CDAS LE 160	3"	1488	89	5355	3150
3 x CDAS LE 170	3"	1700	102	6120	3600

Vacuum Pump Part Number and kW

Vacuum Pump 50Hz / 60Hz	kW @ 50Hz	kW @ 60Hz
HLVAP-OL-02-100	3	3.6
HLVAP-OL-02-110	3	3.6
HLVAP-OL-02-120	4	4.8
HLVAP-OL-02-130	5.5	6.6
HLVAP-OL-02-140	5.5	6.6
HLVAP-OL-02-150	7	8.4
HLVAP-OL-02-160	8.5	10.2
HLVAP-OL-02-170	9.5	11.4

Dryer and vacuum pump to be ordered separately.
 HLVAP-OL-02-100 to HLVAP-OL-02-140 = Single Pump
 HLVAP-OL-02-150 to HLVAP-OL-02-170 = Duplex Pump (Duplex = 2 x pumps supplied on frame)
 Multi-bank dryer installations require multiples vacuum pumps.
 For example, 3 x CDAS LE 170 requires 3 x HLVAP-OL-02-170 pumps or alternatively consider connection to a centralised vacuum system.

Stated flows are for operation at 7 bar (g) (102 psi g) with reference to 20°C, 1 bar (a), 0% relative water vapour pressure. For flows at other pressures, apply the correction factors shown below.

For correct operation, compressed air dryers must be sized for the maximum (summer) inlet temperature, maximum (summer) ambient temperature, minimum inlet pressure, required outlet dewpoint and maximum flow rate of the installation.

CFMIT - Correction Factor Maximum Inlet Temperature

Maximum Inlet Temperature	°C	25	30	35	40	45	50
	°F	77	86	95	104	113	122
Correction Factor		1.00	1.00	1.00	1.04	1.14	1.37

To select a dryer, first calculate the Minimum Drying Capacity (MDC) using the formula below then select a dryer from the flow rate table above with a flow rate equal to or above the MDC.

CFMAT - Correction Factor Maximum Ambient Temperature

Maximum Ambient Temperature	°C	25	30	35	40	45	50
	°F	77	86	95	104	113	122
Correction Factor		1.00	1.00	1.00	1.00	1.00	1.00

Minimum Drying Capacity (MDC) =

Max System Flow x CFMIT x CFMAT x CFMIP x CFOD

CFMIP - Correction Factor Minimum Inlet Pressure

Minimum Inlet Pressure	bar g	4	5	6	7	8	9	10	11	12	13
	psi g	58	73	87	100	116	131	145	160	174	189
Correction Factor		1.60	1.33	1.14	1.00	0.89	0.80	0.73	0.67	0.62	0.57

CFOD - Correction Factor Outlet Dewpoint

Outlet Dewpoint	°C	-20	-40	-70
	°F	-4	-40	-100
Correction Factor		0.91	1.00	1.43

Controller Main Functions

Dryer Models	Controller Function							
	Touchscreen + PLC Controller	Inlet Pressure, Temp. & Outlet Dewpoint Monitoring	DDS Energy Saving Technology	Filter and Dryer Service Indicators	Web Interface via RJ45 Ethernet	I IOT Connectivity	4-20mA Outputs	Fault Alarm Relay
CDAS LE 100 - CDAS LE 170	•	•	•	•	•	•	•	•

Items Included/Required/Optional to Create CDAS LE Package

Product	Required - To be ordered separately	Included	Optional
OIL-X Grade WS (Installation dependent)	-	-	•
OIL-X Grade AO General Purpose Coalescing Filter	-	•	-
OIL-X Grade AA High Efficiency Coalescing Filter	-	•	-
CDAS Adsorption Dryer	-	•	-
OVR Oil Vapour Reduction Filter	-	-	-
OIL-X Grade AO General Purpose Dry Particulate Filter	-	•	-
HLVAP Vacuum Pump(s) (Includes vacuum valve, 3m vacuum hose and fittings)	•	-	-
Inlet / Outlet Piping (Parker Transair aluminium piping recommended)	•	-	-

Included Filtration

Model	Filter Connections BSPP	Dryer Inlet		Dryer Outlet		
		General Purpose Pre-filter	High Efficiency Filter	Oil Vapour Reduction Filter	General Purpose Dry Particulate Filter	High Efficiency Dry Particulate Filter
CDAS LE 100	2"	AOPX040HGFX	AAPX040HGFX	-	AOPX040HGMX	-
CDAS LE 110	2"	AOPX040HGFX	AAPX040HGFX	-	AOPX040HGMX	-
CDAS LE 120	2½"	AOPX045IGFX	AAPX045IGFX	-	AOPX045IGMX	-
CDAS LE 130	2½"	AOPX045IGFX	AAPX045IGFX	-	AOPX045IGMX	-
CDAS LE 140	2½"	AOPX050IGFX	AAPX050IGFX	-	AOPX050IGMX	-
CDAS LE 150	2½"	AOPX050IGFX	AAPX050IGFX	-	AOPX050IGMX	-
CDAS LE 160	3"	AOPX055JGFX	AAPX055JGFX	-	AOPX055JGMX	-
CDAS LE 170	3"	AOPX055JGFX	AAPX055JGFX	-	AOPX055JGMX	-

Filtration Performance

Filter	General Purpose Pre-filter	High Efficiency Filter	Oil Vapour Reduction Filter	General Purpose Dry Particulate Filter	High Efficiency Dry Particulate Filter
Filtration Grade	Grade AO	Grade AA	-	Grade AO	-
Filtration Type	Coalescing	Coalescing	-	Dry Particulate	-
Particle Reduction (inc. water and oil aerosols)	Down to 1 micron	Down to 0.01 micron	-	Down to 1 micron	-
Maximum Remaining Oil Aerosol Content at 21°C	≤0.5 mg/m ³ (≤0.5 ppm(w))	≤0.01 mg/m ³ (≤0.01 ppm(w))	-	N/A	-
Maximum Remaining Oil Vapour Content at System Temperature	N/A	N/A	-	N/A	-
Filtration Efficiency	99.925%	99.9999%	-	99.925%	-

Required in addition to above - To be ordered separately

CDAS LE 100 - CDAS LE 170

Vacuum assist pump (CDAS / OFAS LE 100 - 170 models only) (Parker HLVAP Vacuum Pump recommended - see table)	•
OIL-X Grade WS (Optional - installation dependent)	•
Inlet / Outlet Piping (Parker Transair aluminium piping recommended)	•

Important Note: CDAS models CDAS LE 100 - CDAS LE 170 will not function in Low Energy mode without a vacuum pump. Vacuum pump MUST be ordered separately along with CDAS LE dryer.

Dryer Performance - OFAS HL 100-170

Dryer Models	Dewpoint (Standard)		ISO 8573-1:2010 Classification (Standard)	Dewpoint (Option 1)		ISO 8573-1:2010 Classification (Option 1)	Dewpoint (Option 2)		ISO 8573-1:2010 Classification (Option 2)
	°C	°F		°C	°F		°C	°F	
OFAS HL 100 - OFAS HL 170	-40	-40	Class 2:2:0	-70	-100	Class 2:1:0	-20	-4	Class 2:3:0

ISO 8573-1 Classifications when used with Parker OIL-X pre/post filtration

Technical Data

Dryer Models	Minimum Operating Pressure		Maximum Operating Pressure		Minimum Operating Temperature		Maximum Operating Temperature		Maximum Ambient Temperature		Electrical Supply (Standard)	Electrical Supply (Optional)	Thread Type	Noise Level dB(A)
	bar g	psi g	bar g	psi g	°C	°F	°C	°F	°C	°F				
OFAS HL 100 - OFAS HL 170	5	73	13	190	5	41	50	122	55	131	100-240V (+/-10%) 1ph 50/60Hz	-	BSPP	<75

Flow Rates

Model	Pipe Size	Inlet Flow Rate			
		L/s	m³/min	m³/hr	cfm
OFAS HL 100	2"	113	6.81	408	240
OFAS HL 110	2"	170	10.22	612	360
OFAS HL 120	2½"	213	12.75	765	450
OFAS HL 130	2½"	283	17	1020	600
OFAS HL 140	2½"	354	21	1275	750
OFAS HL 150	2½"	425	26	1530	900
OFAS HL 160	3"	496	30	1785	1050
OFAS HL 170	3"	567	34	2040	1200
2 x OFAS HL 140	2½"	708	43	2550	1500
2 x OFAS HL 150	2½"	850	51	3060	1800
2 x OFAS HL 160	3"	992	60	3570	2100
2 x OFAS HL 170	3"	1133	68	4080	2400
3 x OFAS HL 150	2½"	1275	77	4590	2700
3 x OFAS HL 160	3"	1488	89	5355	3150
3 x OFAS HL 170	3"	1700	102	6120	3600

Stated flows are for operation at 7 bar (g) (102 psi g) with reference to 20°C, 1 bar (a), 0% relative water vapour pressure. For flows at other pressures, apply the correction factors shown below.

For correct operation, compressed air dryers must be sized for the maximum (summer) inlet temperature, maximum (summer) ambient temperature, minimum inlet pressure, required outlet dewpoint and maximum flow rate of the installation.

CFMIT - Correction Factor Maximum Inlet Temperature

Maximum Inlet Temperature	°C	25	30	35	40	45	50
	°F	77	86	95	104	113	122
Correction Factor		1.00	1.00	1.00	1.04	1.14	1.37

To select a dryer, first calculate the Minimum Drying Capacity (MDC) using the formula below then select a dryer from the flow rate table above with a flow rate equal to or above the MDC.

CFMAT - Correction Factor Maximum Ambient Temperature

Maximum Ambient Temperature	°C	25	30	35	40	45	50
	°F	77	86	95	104	113	122
Correction Factor		1.00	1.00	1.00	1.00	1.00	1.00

Minimum Drying Capacity (MDC) =

Max System Flow x CFMIT x CFMAT x CFMIP x CFOD

CFMIP - Correction Factor Minimum Inlet Pressure

Minimum Inlet Pressure	bar g	4	5	6	7	8	9	10	11	12	13
	psi g	58	73	87	100	116	131	145	160	174	189
Correction Factor		1.60	1.33	1.14	1.00	0.89	0.80	0.73	0.67	0.62	0.57

CFOD - Correction Factor Outlet Dewpoint

Outlet Dewpoint	°C	-20	-40	-70
	°F	-4	-40	-100
Correction Factor		0.91	1.00	1.43

Controller Main Functions

Dryer Models	Controller Function							
	Touchscreen + PLC Controller	Inlet Pressure, Temp. & Outlet Dewpoint Monitoring	DDS Energy Saving Technology	Filter and Dryer Service Indicators	Web Interface via RJ45 Ethernet	IOT Connectivity	4-20mA Outputs	Fault Alarm Relay
OFAS HL 100 - OFAS HL 170	•	•	•	•	•	•	•	•

Items Included/Required/Optional to Create OFAS HL Package

Product	Required - To be ordered separately	Included	Optional
OIL-X Grade WS (Installation dependent)	-	-	•
OIL-X Grade AO General Purpose Coalescing Filter	-	•	-
OIL-X Grade AA High Efficiency Coalescing Filter	-	•	-
OFAS Adsorption Dryer	-	•	-
OVR Oil Vapour Reduction Filter	-	•	-
OIL-X Grade AO General Purpose Dry Particulate Filter	-	•	-
HLVAP Vacuum Pump(s) (Includes vacuum valve, 3m vacuum hose and fittings)	-	-	-
Inlet / Outlet Piping (Parker Transair aluminium piping recommended)	•	-	-

Included Filtration

Model	Filter Connections BSPP	Dryer Inlet		Dryer Outlet		
		General Purpose Pre-filter	High Efficiency Filter	Oil Vapour Reduction Filter	General Purpose Dry Particulate Filter	High Efficiency Dry Particulate Filter
OFAS HL 100	2"	AOPX040HGFX	AAPX040HGFX	OVRP350HGXX	AOPX040HGMX	-
OFAS HL 110	2"	AOPX040HGFX	AAPX040HGFX	OVRP400HGXX	AOPX040HGMX	-
OFAS HL 120	2½"	AOPX045IGFX	AAPX045IGFX	OVRP400IGXX	AOPX045IGMX	-
OFAS HL 130	2½"	AOPX045IGFX	AAPX045IGFX	OVRP400IGXX	AOPX045IGMX	-
OFAS HL 140	2½"	AOPX050IGFX	AAPX050IGFX	OVRP450IGXX	AOPX050IGMX	-
OFAS HL 150	2½"	AOPX050IGFX	AAPX050IGFX	OVRP450IGXX	AOPX050IGMX	-
OFAS HL 160	3"	AOPX055JGFX	AAPX055JGFX	OVRP500JGXX	AOPX055JGMX	-
OFAS HL 170	3"	AOPX055JGFX	AAPX055JGFX	OVRP500JGXX	AOPX055JGMX	-

Filtration Performance

Filter	General Purpose Pre-filter	High Efficiency Filter	Oil Vapour Reduction Filter	General Purpose Dry Particulate Filter	High Efficiency Dry Particulate Filter
Filtration Grade	Grade AO	Grade AA	Grade OVR	Grade AO	-
Filtration Type	Coalescing	Coalescing	Adsorption	Dry Particulate	-
Particle Reduction (inc. water and oil aerosols)	Down to 1 micron	Down to 0.01 micron	N/A	Down to 1 micron	-
Maximum Remaining Oil Aerosol Content at 21°C	≤0.5 mg/m ³ (≤0.5 ppm(w))	≤0.01 mg/m ³ (≤0.01 ppm(w))	N/A	N/A	-
Maximum Remaining Oil Vapour Content at System Temperature	N/A	N/A	≤0.003 mg/m ³ (≤0.003 ppm(w))	N/A	-
Filtration Efficiency	99.925%	99.9999%	N/A	99.925%	-

Required in addition to above - To be ordered separately

	OFAS HL 100 - OFAS HL 170
OIL-X Grade WS (Optional - installation dependent)	•
Inlet / Outlet Piping (Parker Transair aluminium piping recommended)	•

Dryer Performance - OFAS LE 100-170

Dryer Models	Dewpoint (Standard)		ISO 8573-1:2010 Classification (Standard)	Dewpoint (Option 1)		ISO 8573-1:2010 Classification (Option 1)	Dewpoint (Option 2)		ISO 8573-1:2010 Classification (Option 2)
	°C	°F		°C	°F		°C	°F	
OFAS LE 100 - OFAS LE 170	-40	-40	Class 2:2:0	-70	-100	Class 2:1:0	-20	-4	Class 2:3:0

ISO 8573-1 Classifications when used with Parker OIL-X pre/post filtration

Technical Data

Dryer Models	Minimum Operating Pressure		Maximum Operating Pressure		Minimum Operating Temperature		Maximum Operating Temperature		Maximum Ambient Temperature		Electrical Supply (Standard)	Electrical Supply (Optional)	Thread Type	Noise Level dB(A)
	bar g	psi g	bar g	psi g	°C	°F	°C	°F	°C	°F				
OFAS LE 100 - OFAS LE 170	5	73	13	190	5	41	50	122	55	131	400V +/-10% 3PH 50Hz	460V +/-10% 3PH 60Hz	BSPP	<75

Flow Rates

Model	Pipe Size	Inlet Flow Rate			
		L/s	m³/min	m³/hr	cfm
OFAS LE 100	2"	113	6.81	408	240
OFAS LE 110	2"	170	10.22	612	360
OFAS LE 120	2½"	213	12.75	765	450
OFAS LE 130	2½"	283	17	1020	600
OFAS LE 140	2½"	354	21	1275	750
OFAS LE 150	2½"	425	26	1530	900
OFAS LE 160	3"	496	30	1785	1050
OFAS LE 170	3"	567	34	2040	1200
2 x OFAS LE 140	2½"	708	43	2550	1500
2 x OFAS LE 150	2½"	850	51	3060	1800
2 x OFAS LE 160	3"	992	60	3570	2100
2 x OFAS LE 170	3"	1133	68	4080	2400
3 x OFAS LE 150	2½"	1275	77	4590	2700
3 x OFAS LE 160	3"	1488	89	5355	3150
3 x OFAS LE 170	3"	1700	102	6120	3600

Vacuum Pump Part Number and kW

Vacuum Pump 50Hz / 60Hz	kW @ 50Hz	kW @ 60Hz
HLVAP-OL-02-100	3	3.6
HLVAP-OL-02-110	3	3.6
HLVAP-OL-02-120	4	4.8
HLVAP-OL-02-130	5.5	6.6
HLVAP-OL-02-140	5.5	6.6
HLVAP-OL-02-150	7	8.4
HLVAP-OL-02-160	8.5	10.2
HLVAP-OL-02-170	9.5	11.4

Dryer and vacuum pump to be ordered separately.
 HLVAP-OL-02-100 to HLVAP-OL-02-140 = Single Pump
 HLVAP-OL-02-150 to HLVAP-OL-02-170 = Duplex Pump
 (Duplex = 2 x pumps supplied on frame)
 Multi-bank dryer installations require multiples vacuum pumps.
 For example, 3 x OFAS LE 170 requires 3 x HLVAP-OL-02-170 pumps or alternatively consider connection to a centralised vacuum system.

Stated flows are for operation at 7 bar (g) (102 psi g) with reference to 20°C, 1 bar (a), 0% relative water vapour pressure. For flows at other pressures, apply the correction factors shown below.

For correct operation, compressed air dryers must be sized for the maximum (summer) inlet temperature, maximum (summer) ambient temperature, minimum inlet pressure, required outlet dewpoint and maximum flow rate of the installation.

CFMIT - Correction Factor Maximum Inlet Temperature

Maximum Inlet Temperature	°C	25	30	35	40	45	50
	°F	77	86	95	104	113	122
Correction Factor		1.00	1.00	1.00	1.04	1.14	1.37

To select a dryer, first calculate the Minimum Drying Capacity (MDC) using the formula below then select a dryer from the flow rate table above with a flow rate equal to or above the MDC.

CFMAT - Correction Factor Maximum Ambient Temperature

Maximum Ambient Temperature	°C	25	30	35	40	45	50
	°F	77	86	95	104	113	122
Correction Factor		1.00	1.00	1.00	1.00	1.00	1.00

Minimum Drying Capacity (MDC) =

Max System Flow x CFMIT x CFMAT x CFMIP x CFOD

CFMIP - Correction Factor Minimum Inlet Pressure

Minimum Inlet Pressure	bar g	4	5	6	7	8	9	10	11	12	13
	psi g	58	73	87	100	116	131	145	160	174	189
Correction Factor		1.60	1.33	1.14	1.00	0.89	0.80	0.73	0.67	0.62	0.57

CFOD - Correction Factor Outlet Dewpoint

Outlet Dewpoint	°C	-20	-40	-70
	°F	-4	-40	-100
Correction Factor		0.91	1.00	1.43

Controller Main Functions

Dryer Models	Controller Function							
	Touchscreen + PLC Controller	Inlet Pressure, Temp. & Outlet Dewpoint Monitoring	DDS Energy Saving Technology	Filter and Dryer Service Indicators	Web Interface via RJ45 Ethernet	I IOT Connectivity	4-20mA Outputs	Fault Alarm Relay
OFAS LE 100 - OFAS LE 170	•	•	•	•	•	•	•	•

Items Included/Required/Optional to Create OFAS LE Package

Product	Required - To be ordered separately	Included	Optional
OIL-X Grade WS (installation dependent)	-	-	•
OIL-X Grade AO General Purpose Coalescing Filter	-	•	-
OIL-X Grade AA High Efficiency Coalescing Filter	-	•	-
OFAS Adsorption Dryer	-	•	-
OVR Oil Vapour Reduction Filter	-	•	-
OIL-X Grade AO General Purpose Dry Particulate Filter	-	•	-
HLVAP Vacuum Pump(s) (Includes vacuum valve, 3m vacuum hose and fittings)	•	-	-
Inlet / Outlet Piping (Parker Transair aluminium piping recommended)	•	-	-

Included Filtration

Model	Filter Connections BSPP	Dryer Inlet		Dryer Outlet		
		General Purpose Pre-filter	High Efficiency Filter	Oil Vapour Reduction Filter	General Purpose Dry Particulate Filter	High Efficiency Dry Particulate Filter
OFAS LE 100	2"	AOPX040HGFX	AAPX040HGFX	OVRP350HGXX	AOPX040HGMX	-
OFAS LE 110	2"	AOPX040HGFX	AAPX040HGFX	OVRP400HGXX	AOPX040HGMX	-
OFAS LE 120	2½"	AOPX045IGFX	AAPX045IGFX	OVRP400IGXX	AOPX045IGMX	-
OFAS LE 130	2½"	AOPX045IGFX	AAPX045IGFX	OVRP400IGXX	AOPX045IGMX	-
OFAS LE 140	2½"	AOPX050IGFX	AAPX050IGFX	OVRP450IGXX	AOPX050IGMX	-
OFAS LE 150	2½"	AOPX050IGFX	AAPX050IGFX	OVRP450IGXX	AOPX050IGMX	-
OFAS LE 160	3"	AOPX055JGFX	AAPX055JGFX	OVRP500JGXX	AOPX055JGMX	-
OFAS LE 170	3"	AOPX055JGFX	AAPX055JGFX	OVRP500JGXX	AOPX055JGMX	-

Filtration Performance

Filter	General Purpose Pre-filter	High Efficiency Filter	Oil Vapour Reduction Filter	General Purpose Dry Particulate Filter	High Efficiency Dry Particulate Filter
Filtration Grade	Grade AO	Grade AA	Grade OVR	Grade AO	-
Filtration Type	Coalescing	Coalescing	Adsorption	Dry Particulate	-
Particle Reduction (inc. water and oil aerosols)	Down to 1 micron	Down to 0.01 micron	N/A	Down to 1 micron	-
Maximum Remaining Oil Aerosol Content at 21°C	≤0.5 mg/m ³ (≤0.5 ppm(w))	≤0.01 mg/m ³ (≤0.01 ppm(w))	N/A	N/A	-
Maximum Remaining Oil Vapour Content at System Temperature	N/A	N/A	≤0.003 mg/m ³ (≤0.003 ppm(w))	N/A	-
Filtration Efficiency	99.925%	99.9999%	N/A	99.925%	-

Required in addition to above - To be ordered separately

OFAS LE 100 - OFAS LE 170

Vacuum assist pump (CDAS/OFAS LE 100 - 170 models only) (Parker HLVAP Vacuum Pump recommended - see table)	•
OIL-X Grade WS (Optional - installation dependent)	•
Inlet/Outlet Piping (Parker Transair aluminium piping recommended)	•

Important Note: OFAS models OFAS LE 100 - OFAS LE 170 will not function in Low Energy mode without a vacuum pump. Vacuum pump MUST be ordered separately along with OFAS LE dryer.

Weights and Dimensions (CDAS/OFAS HL and CDAS/OFAS LE - Dryer Only)

Dryer Model	Pipe Size BSSP	Dimensions (Dryer Only)						Weight (Dryer Only)	
		Height (H)		Width (W)		Depth (D)		kg	lbs
		mm	ins	mm	ins	mm	ins		
CDAS/OFAS HL & LE 100	2"	1672	65.8	816	32.1	550	21.7	217	478
CDAS/OFAS HL & LE 110	2"	1672	65.8	987	38.9	550	21.7	277	611
CDAS/OFAS HL & LE 120	2½"	1917	75.5	987	38.9	550	21.7	372	820
CDAS/OFAS HL & LE 130	2½"	1917	75.5	1156	45.5	550	21.7	464	1023
CDAS/OFAS HL & LE 140	2½"	1917	75.5	1325	52.2	550	21.7	555	1224
CDAS/OFAS HL & LE 150	2½"	1917	75.5	1494	58.8	550	21.7	646	1424
CDAS/OFAS HL & LE 160	3"	1917	75.5	1663	65.5	550	21.7	739	1629
CDAS/OFAS HL & LE 170	3"	1917	75.5	1832	72.1	550	21.7	830	1830

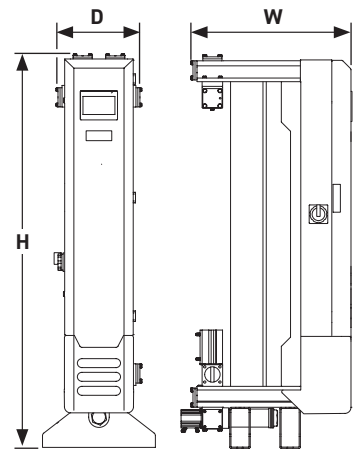

Quality Assurance/IP Rating/Pressure Vessel Approvals

Development/Manufacture	ISO 9001 / ISO 14001 / Materials of Construction FDA Title 21 CFR Compliant and EC1935/2004 Exempt
Ingress Protection Rating	IP44 Indoor Use Only
EU/ UK	Pressure vessel approved for fluid group 2 in accordance with the Pressure Equipment Directive 2014/68/EU
USA	Approval to ASME VIII Div. 1 not required
AUS	AS1210
For use with compressed air only.	

Weights and Dimensions (HLVAP-OL-02 Vacuum Pumps)

Vacuum Pump Model	Vacuum Pump Dimensions							
	Height (H)		Width (W)		Depth (D)		Weight	
	mm	ins	mm	ins	mm	ins	kg	lbs
HLVAP-OL-02-100	400	15.75	933	36.73	523	20.59	89	196
HLVAP-OL-02-110	400	15.75	933	36.73	523	20.59	89	196
HLVAP-OL-02-120	400	15.75	933	36.73	523	20.59	194	428
HLVAP-OL-02-130	400	15.75	933	36.73	523	20.59	184	406
HLVAP-OL-02-140	400	15.75	933	36.73	523	20.59	184	406
HLVAP-OL-02-150	1304	51.34	1100	43.31	560	22.05	420	926
HLVAP-OL-02-160	1304	51.34	1100	43.31	560	22.05	390	860
HLVAP-OL-02-170	1304	51.34	1100	43.31	560	22.05	390	860

HLVAP-OL-02-100 - HLVAP-OL-02-140
SINGLE VACUUM PUMP

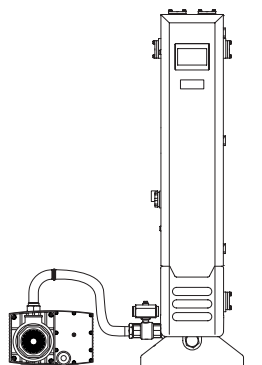

HLVAP-OL-02-150 - HLVAP-OL-02-170
DUPLEX VACUUM PUMP

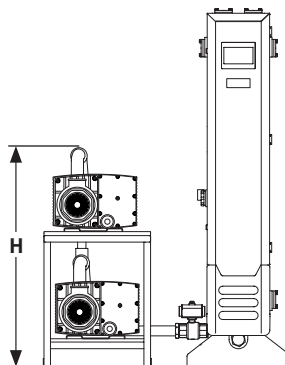

VACUUM PUMP

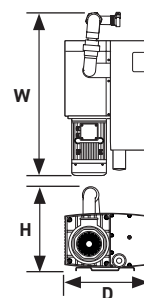

Included Filtration and Optional (Requires Ordering Separately)

Dryer Model		OIL-X Filter Grade WS Liquid Separator	OIL-X Filter Grade AO General Purpose Coalescing Filter	OIL-X Filter Grade AA High Efficiency Coalescing Filter	OIL-X Filter Grade OVR Adsorption Filter	OIL-X Filter Grade AO(M) General Purpose Dry Particulate Filter
Clean Dry Air System	CDAS HL 100-170	Optional (Order Separately)	Included	Included	-	Included
	CDAS LE 100-170	Optional (Order Separately)	Included	Included	-	Included
Oil-Free Air System	OFAS HL 100-170	Optional (Order Separately)	Included	Included	Included	Included
	OFAS LE 100-170	Optional (Order Separately)	Included	Included	Included	Included

Weights and Dimensions - Included Filtration (All CDAS/OFAS 100-170 models)

Filter Model	Filter Connections BSP	Height (H)		Width (W)		Depth (D)		Weight	
		mm	ins	mm	ins	mm	ins	kg	lbs
040H	2"	532	20.94	164	6.46	157	6.18	7.18	15.82
045I	2½"	532	20.94	164	6.46	157	6.18	7.18	15.82
050I	2½"	654	25.75	192	7.56	183	7.20	10.18	22.43
055J	3"	844	33.23	192	7.56	183	7.20	15.78	34.78

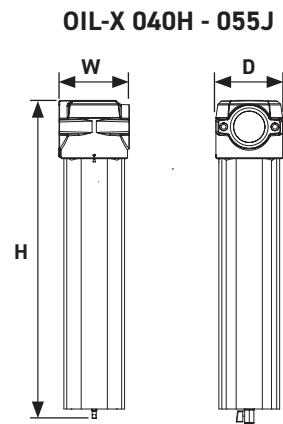

Weights and Dimensions - Included OVR (All CDAS/OFAS 100-170 models)

Filter Model	Filter Connections BSP	Height (H)		Width (W)		Depth (D)		Weight	
		mm	ins	mm	ins	mm	ins	kg	lbs
OVRP350H	2"	1062	41.8	538	21.2	550	21.7	67	147
OVRP400H	2"	1062	41.8	682	26.9	550	21.7	93	205
OVRP400I	2½"	1062	41.8	682	26.9	550	21.7	93	205
OVRP450I	2½"	1062	41.8	836	32.9	550	21.7	121	267
OVRP500J	3"	1062	41.8	1005	39.6	550	21.7	144	318

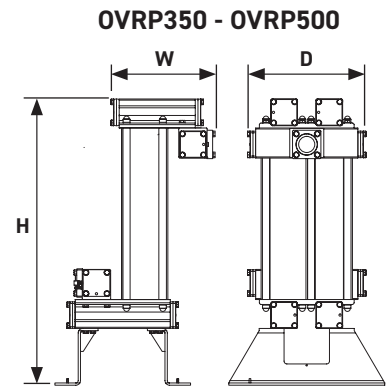

Example Installation: CDAS HL 130



Example Installation: OFAS LE 170



www.parker.com/gsfe



European Headquarters

La Tuilière 6, 1163 Etoy,
Switzerland
Tel: +41 21 821 85 00

EMEA Product Information Centre

Free phone: 00 800 27 27 5374
(from AT, BE, CH, CZ, DE, DK, EE, ES, FI, FR, IE, IL,
IS, IT, LU, MT, NL, NO, PL, PT, RU, SE, SK, UK, ZA)
US Product Information Centre
Toll-free number: 1-800-27 27 537

StarlettePlus-E

Refrigeration dryer series

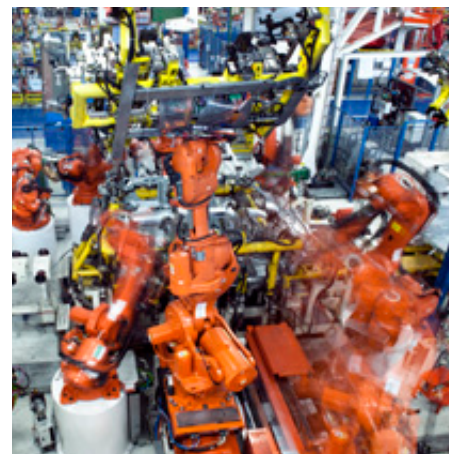

The Parker StarlettePlus-E series of refrigerated dryers (SPE) is the perfect solution for efficient removal of water vapour from compressed air and combines quality and efficiency in a reliable design with the smallest impact on the environment and on the operating costs. Developed around a state-of-the-art Aluminium heat exchanger (E-Pack), with a patent pending all-in-one design, featuring an air-to-air section, an air-to-refrigerant section, a highly efficient stainless steel demister separator and a moisture collection chamber, the new StarlettePlus-E series provides air quality with unrivalled running costs.

Thanks to the highly efficient E-Pack design, the refrigerant circuit absorbs lower power and uses less refrigerant charges than other comparable dryer, making StarlettePlus-E the range in the market with the lowest running costs and the smallest impact on the environment. All models are equipped as standard with a digital controller that provides features useful in the day-by-day operations of any application: dew point level indication, free voltage alarm contact, maintenance reminder and integral timed drain control. In addition, thanks to its dual frequency design, StarlettePlus-E is ready to operate either in 50Hz or 60Hz environments.



A StarlettePlus-E version, equipped with the Energy Save feature, is optionally available for the models from 2.6 m³/min (SPE026 - SPE100). When equipped with this feature, the SPE models will save additional energy at partial load by cycling the fridge compressor activity while cooling the inlet air using the cold reserve stored in the E-Pack mass. Removable panels and internal compo-

nent disposition makes service inspections and maintenance activity a simple task. A pass-through drain niche is also available on all SPE models, allowing easy access to the drain from both sides of the dryer without opening the unit and in particular when it is installed next to a wall or even hung on a wall, thanks to the ready available hanging points (up to model SPE018).

StarlettePlus-E

Refrigeration dryer series

Key Benefits:

- The range with the lowest Carbon Footprint on the market
- The lowest running costs and the lowest absorbed power in this range
- High efficiency all-in-one Aluminium Heat Exchanger ("E-Pack", patent pending)
- Minimum refrigerant charges (avg. 25% lower than comparable ranges)
- Dual-Frequency ready for 50 or 60Hz applications
- Digital controller with:
 - Free contact
 - Maintenance reminder
 - Drain control (timed mode)
- Wall-hang ready (up to model SPE018)
- Easy drain access from both sides
- Compact dimensions

Key Applications:

- Industrial and general air applications requiring a dew point not lower than 3 °C.
E.g.:
 - Manufacturing
 - Automotive
 - Textile, Wood, Glass industry
 - Surface treatment
 - Materials handling
 - Material forming
 - Mining

Scope of supply:

- StarlettePlus-E dryer – supplied ready for installation with:
- Digital Controller
 - Voltage Free alarm contact
 - Maintenance reminder
 - Integral timed drain
 - Dual frequency 50 / 60 Hz ready

Optional:

- External Float or Electronic Capacitive Drain
- Energy Saving versions (from model SPE026)



A pass-through drain niche allows easy drain access from both sides



Equipped with digital controller



Optional pre-filter (not part of the standard scope of supply).

The Energy Save feature

Models from SPE026 to SPE100 can also be available in Energy Saving version (SPE026-ES - SPE100-ES).

The Energy Save feature allows the dryer to absorb lower power by controlling the periods of time the refrigerant compressor remains switched off.

During these periods, the lower load of compressed air is cooled down by the cold accumulated in the aluminium mass of the heat exchanger.

The diagram shows the absorbed power curve and the relevant saving at different loads when the Energy Save function is active.

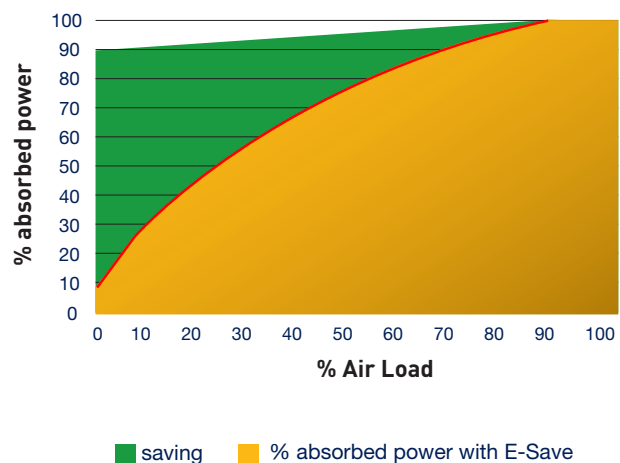

StarlettePlus-E

Refrigeration dryer series

Ordering and performance data

Model	Order-No. Standard version	Air flow 50 Hz		Air flow 60 Hz		Abs. power kW		R134a charge Kg	Air connections BSPP-F
		m³/h	m³/min	m³/h	m³/min	50 Hz	60 Hz		
SPE 004	SPE004-A2301DF16TIS	24	0,4	28	0,47	0,13	0,16	0,14	1/2"
SPE 007	SPE007-A2301DF16TIS	42	0,7	47	0,78	0,14	0,17	0,15	1/2"
SPE 009	SPE009-A2301DF16TIS	54	0,9	60	1,00	0,15	0,19	0,15	1/2"
SPE 014	SPE014-A2301DF16TIS	84	1,4	96	1,60	0,15	0,18	0,17	3/4"
SPE 018	SPE018-A2301DF16TIS	108	1,8	124	2,07	0,16	0,20	0,18	3/4"
SPE 026	SPE026-A2301DF16TIS	156	2,6	176	2,93	0,29	0,36	0,33	1"
SPE 032	SPE032-A2301DF16TIS	192	3,2	218	3,63	0,3	0,37	0,34	1"
SPE 040	SPE040-A2301DF16TIS	240	4	272	4,53	0,31	0,38	0,35	1"
SPE 052	SPE052-A2301DF16TIS	312	5,2	361	6,02	0,46	0,56	0,39	1 1/2"
SPE 062	SPE062-A2301DF16TIS	372	6,2	429	7,15	0,57	0,69	0,4	1 1/2"
SPE 080	SPE080-A2301DF14TIS	480	8	555	9,25	0,73	0,90	0,74	1 1/2"
SPE 100	SPE100-A2301DF14TIS	600	10	689	11,48	0,74	0,91	0,75	1 1/2"

Reference conditions in accordance with DIN ISO 7183: air flow based on FAD 20 °C / 1 bar A, 7 bar_g working pressure, 25 °C cooling air temperature, 35 °C air inlet temperature and +3°C pressure dewpoint. All models supplied with refrigerant R134a.

Operating range

Site Selection	Frost-free indoor installation in a non-hazardous environment
Ambient Temperature	5 to 50 °C
Compressed air inlet temperature	5 to 65 °C
Operating pressure range	2 to 16 bar _g – SPE004-062; 2 to 14 bar _g – SPE080-100
Medium	Compressed air and gaseous nitrogen

Electrical connections

Mains Voltages	230V, 1-phase, 50 Hz and 60Hz (dual frequency ready)
Protection class	IP22

Materials of construction

Heat Exchanger fridge section	All-in-one "E-Pack" Aluminium heat exchanger with Stainless Steel demister
Refrigerant fluid	R134a

Pressure vessel approvals

EU	Approval for fluid group 2 in accordance with the Pressure Equipment Directive 2014/68/EU
----	---

Quality assurance

Development/Manufacturing	ISO 9001, ISO 14001, OHSAS 18001
---------------------------	----------------------------------

Dimensions and weight

Model	A Width mm	B Height mm	C Depth mm	Weight kg	Model	A Width mm	B Height mm	C Depth mm	Weight kg
SPE 004	300	520	400	24	SPE 032	400	650	630	46
SPE 007	300	520	400	24	SPE 040	400	650	630	47
SPE 009	300	520	400	25	SPE 052	400	650	630	53
SPE 014	330	580	550	35	SPE 062	400	650	630	55
SPE 018	330	580	550	36	SPE 080	450	840	780	80
SPE 026	400	650	630	46	SPE 100	450	840	780	80

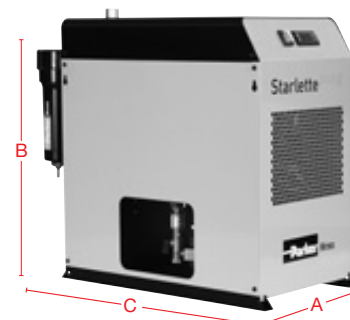

StarlettePlus-E

Refrigeration dryer series

Correction factors for SPE model selection at 50Hz /60 Hz

Inlet Temperature (°C)	30	35	40	45	50	55	60	65
Correction Factor CFIT 50/60 Hz	0,83 0,85	1 1	1,30 1,32	1,61 1,61	2,00 2,04	2,33 2,56	2,38 2,63	2,50 2,78
Working Pressure (bar _g)	3	5	7	9	11	13	15	16
Correction Factor CFP 50/60 Hz	1,35 1,45	1,11 1,11	1 1	0,85 0,85	0,81 0,81	0,77 0,77	0,72 0,73	0,71 0,71
Ambient Temperature (°C)	20	25	30	35	40	45	50	
Correction Factor CFAT 50/60 Hz	0,93 0,96	1 1	1,02 1,06	1,09 1,11	1,15 1,18	1,22 1,25	1,28 1,33	
Pressure Dew Point (°C)	+3	+5	+7					
Correction Factor CFD 50/60 Hz	1 1	0,78 0,79	0,70 0,72					

Calculate Minimum Drying Capacity =
System Flow x CFIT x CFAT x CFP x CFD and select dryer from table above

Example: air flow 190 m³/h, 50 Hz, operating pressure 9bar_g, 40 °C inlet T, 30 °C ambient T, at 3 °C pdp

- 1) Find the correction factors above: 9 bar_g = 0,85; 40 °C inlet = 1,30; 30 °C ambient = 1,02; 3 °C pdp = 1
- 2) Calculate the required capacity: 0,85 x 1,30 x 1,02 = 1,13; 190 x 1,13 = 215 m³/h; 215/60 = 3,6 m³/min
- 3) Select the model with the closest nominal capacity: model **SPE040**

Product Key

Series	Flow *10 (m ³ /min)	Condenser	Electrical Voltage, phase, Dual-Frequency	Max Operating Pressure (bar _g)	Drain Type	Plug Type	Energy Saving version
SPE	004 to 062	A	230 1 DF	16	TI, EX or FH	S	-
SPE	026 to 062	A	230 1 DF	16	EX	S	ES ⁽¹⁾
SPE	080 to 100	A	230 1 DF	14	TI, EX or FH	S	-
SPE	080 to 100	A	230 1 DF	14	EX	S	ES ⁽¹⁾

⁽¹⁾Option available only from model SPE026

Examples

SPE	014	A	2301DF	16	TI	S	
SPE model for 1,4 m ³ /min, air cooled, 230 V, 1-phase, dual-frequency 50/60 Hz power supply, max 16 bar _g operating pressure, equipped with integral timed-drain, Schuko plug							
SPE	052	A	2301DF	16	EX	S	
SPE model for 5,2 m ³ /min, air cooled, 230 V, 1-phase, dual-frequency 50/ 60 Hz power supply, max 16 bar _g operating pressure, equipped with external electronic capacitive drain, Schuko plug							
SPE	080	A	2301DF	14	FH	S	
SPE model for 8,0 m ³ /min, air cooled, 230 V, 1-phase, dual-frequency 50/60 Hz power supply, max 14 bar _g operating pressure, equipped with external float drain, Schuko plug							
SPE	062	A	2301DF	16	EX	S	ES
SPE model for 6,2 m ³ /min, air cooled, 230 V, 1-phase, dual-frequency 50/60 Hz power supply, max 16 bar _g operating pressure, equipped with external capacity drain, Energy Saving model version, Schuko plug							

EMEA Product Information Centre

Free phone: 00 800 27 27 5374

(from AT, BE, CH, CZ, DE, DK, EE, ES, FI, FR, IE, IL, IS, IT, LU, MT, NL, NO, PL, PT, RU, SE, SK, UK, ZA)

US Product Information Centre

Toll-free number: 1-800-27 27 537

www.parker.com/gsf

